

# INSULATED CASING CLASS SMOKE VENTING FAN

Rev.01  
27-05-2015



## GMC SVF-622:

Available in 5 sizes and 20 models, the **SVF-622** range covers flow rates from 600 to 50,000 m<sup>3</sup>/hr either in forward-swept blade fan version, **SVF-622: Mk.A** for pressures up to 1,500 Pa or backward-swept blade version, **SVF-622: Mk.R** or pressures up to 2,600 Pa. The **SVF-622: Mk.R** version fitted with a backward-swept blade fan is especially suitable and recommended for applications in professional kitchens or for the extraction of foul contaminated air (car parks, industry, etc.)

### Application

- Smoke extraction units meeting legislative requirements for the extraction of smoke and hot gases in the event of fire in high rise buildings and public assembly buildings
- Range also designed for the extraction of contaminated air from industrial premises, professional kitchens and car parks, etc



**HVAC Systems and Equipments Co.**  
4640 Hedgcoxe Road 227 Plano, TX 75024 – US

[www.gmcair.com](http://www.gmcair.com) 

# INSULATED CASING CLASS SMOKE VENTING FAN

Rev.01  
27-05-2015



- The **SVF-622** system is F400-120 approved by the CTICM and covered by the CE certificate for smoke and heat extractor fans in compliance with standard NF EN 12101-3
- The **SVF-622** range can be installed indoors or outdoors

## Composition

- Housing in 15/10 galvanized steel sheet free standing on 20 to 30/10 galvanized steel frame from reinforced by a central strut from model SVF-622: Mk.25 on
- Access panel fitted with a hinged door with handle for the motor compartment and wide removable panel for maintaining the fan
- Ground fixings fit directly into the slots provided in the frame
- Intake and outlet by circular connections up to model **SVF-622: Mk.12**, square on the other models
- The motor support consists of a galvanized steel plate reinforced by raised edges fully extractable and sliding on rails for maintenance and adjustment. The design of the motor compartment enables the overall dimensions of the unit to be limited with the option of blocking off the side opposite the access face. The transmission tension is adjusted from the outside, outlet face side, by a system using a chassis sliding on rails
- SVF-622: Mk.A Fan with forward-facing blades and double inlet in galvanized steel, balanced statically and dynamically, fitted with an aluminium hub and coupled to the motor by belt(s) and pulley(s)
- SVF-622: Mk.R Fan with backward-facing blades and double inlet in steel protected by epoxy paint, balanced statically and dynamically, fitted with an aluminium hub and coupled to the motor by belt(s) and pulley(s)
- B3 motor, protection IP 55 class F overheating B - 1 speed three-phase 230/400V or 400/690V (motors > 5.5 kW), 50 or 60 Hz, (2 and 4 poles).  
- 2 speed three-phase 400V, 50 Hz, Dahlander winding (2/4 and 4/8 P), independent windings (4/6 P)
- Protective housing for the transmission on the fan compartment side, easily removable for belt replacement
- Variable drive pulley up to 5.5 kW

## Installation

- The **SVF-622** range can be installed indoors or outdoors.
- Access is on the right, viewed in the air direction, as standard, on the left on request or can be easily changed on site if required.
- Outlet horizontal in line or vertical at 90°.
- Can be installed vertically against a wall.

## Variants F400-120 approved by CTICM

- Acoustic insulation in very high density 25 mm -120 kg/m<sup>3</sup> mineral wool providing powerful acoustic attenuation (IPH option)
- Double skin insulation (IDP), standard external face in 15/10 galvanized sheet, internal face in 10/10 galvanized sheet and insulation in high density mineral wool, 25 mm - 60 kg/m<sup>3</sup>
- Recommended for installations requiring regular maintenance of the unit while providing attenuation of the sound levels radiated (professional kitchens, etc.)
- The IPH and IDP variants classify the **SVF-622**, range up to model 12 in the category of F400-120 **ISOLÉ THERMIQUEMENT**. smoke extraction fans approved and certified by the CTICM
- Condensate tray at bottom of unit (ECP option) for removal of condensates
- Access is on the right, viewed in the air direction, as standard, on the left on request or can be easily changed on site if required
- Outlet horizontal in line or vertical at 90°
- Compatible with the standard or IDP versions

## Dimensions

Model	A (mm)	B (mm)	H (mm)	O (mm)	E (mm)	F (mm)	L (mm)	A1 (mm)	H1 (mm)	H2 (mm)	X (mm)	X1 (mm)	Y (mm)	
Mk.	4 A - R	1055	650	745	450	\	\	210	155	240	1090	\	520	
	6 A - R	1055	650	745	500	\	\	385	190	215	1090	\	520	
	10 A - R	1350	850	940	630	\	\	300	160	270	1380	\	680	
	12 A - R	1350	850	940	710	\	\	235	120	200	1380	\	680	
	15 A - R	1450	1070	1170	\	868	947	513	355	190	575	1390	\	840
	20 A - R	1450	1070	1170	\	868	947	575	290	190	545	1390	\	840
	25 A - R	1685	1320	1345	\	1122	1122	644	420	190	570	1630	445	1080
	30 A - R	1685	1320	1345	\	1122	1122	721	340	190	575	1630	445	1080
	40 A - R	1955	1660	1485	\	1458	1262	807	525	190	565	1900	445	1380
	50 A - R	1955	1660	1485	\	1458	1262	940	430	190	530	1900	445	1380

	63 Hz	125 Hz	250 Hz	500 Hz	1 kHz	2 kHz	4 kHz	8 kHz
IPH	0	-1	-2	-3	-3	-4	-5	-6
IDP	0	0	-1	-1	-2	-3	-2	-2

Model	Lpa (dBA)					
	1,5m	3m	4m	5m	7m	10m
SVF-622: Mk.A	24	18	15	13	10	7
SVF-622: Mk.R	21	15	12	10	7	4



# INSULATED CASING CLASS SMOKE VENTING FAN

Rev.01  
27-05-2015



## Configurations

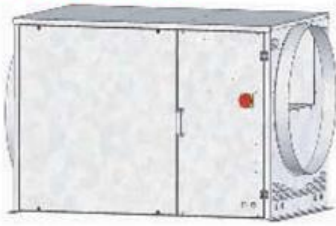

1

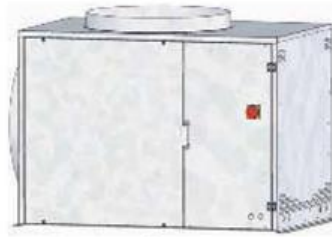

2



3

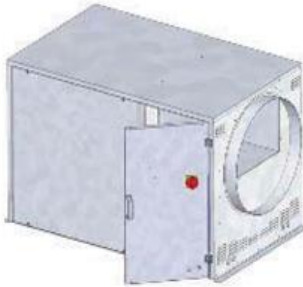

5

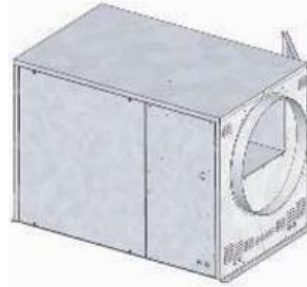

4

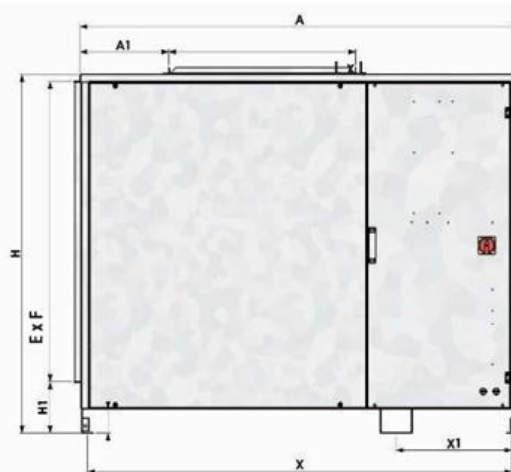
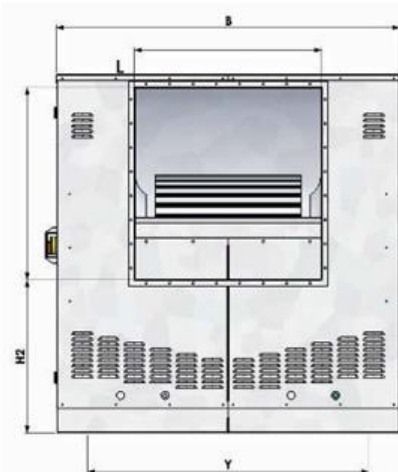
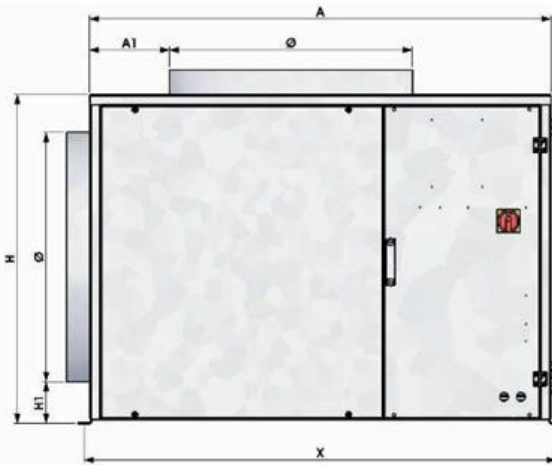
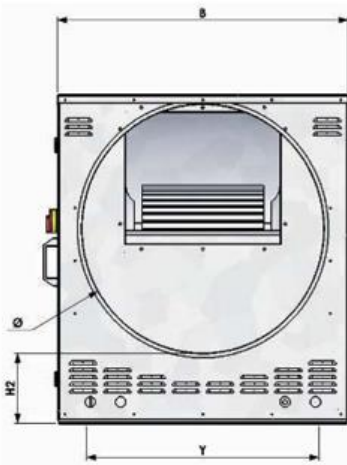

# INSULATED CASING CLASS SMOKE VENTING FAN

Rev.01  
27-05-2015



## Explanatory notes to Graphs

- P<sub>dyn</sub> A – Dynamic pressure free outlet
- P<sub>dyn</sub> D - Dynamic pressure ducted outlet

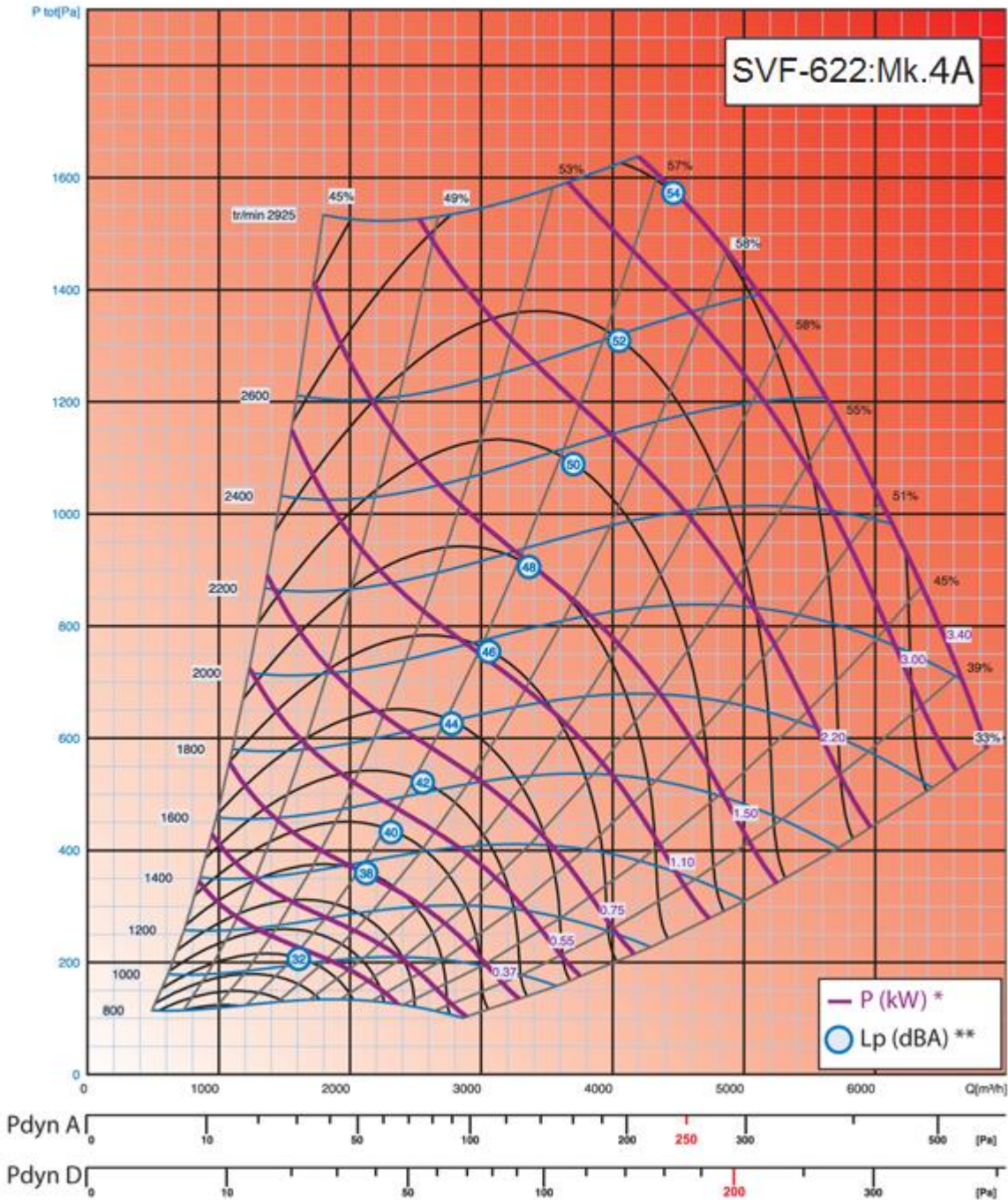

# INSULATED CASING CLASS SMOKE VENTING FAN

Rev.01  
27-05-2015

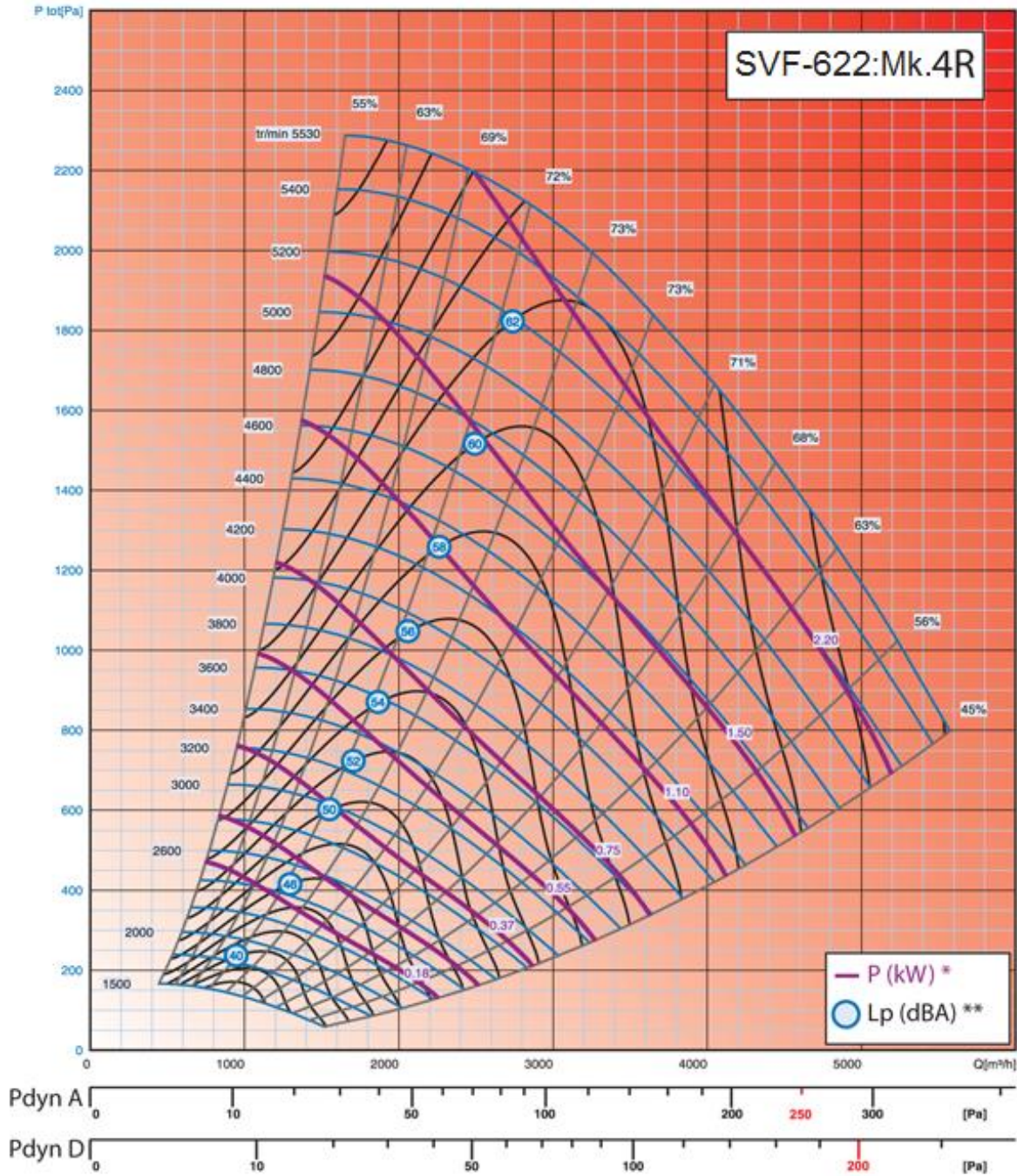

# INSULATED CASING CLASS SMOKE VENTING FAN

Rev.01  
27-05-2015

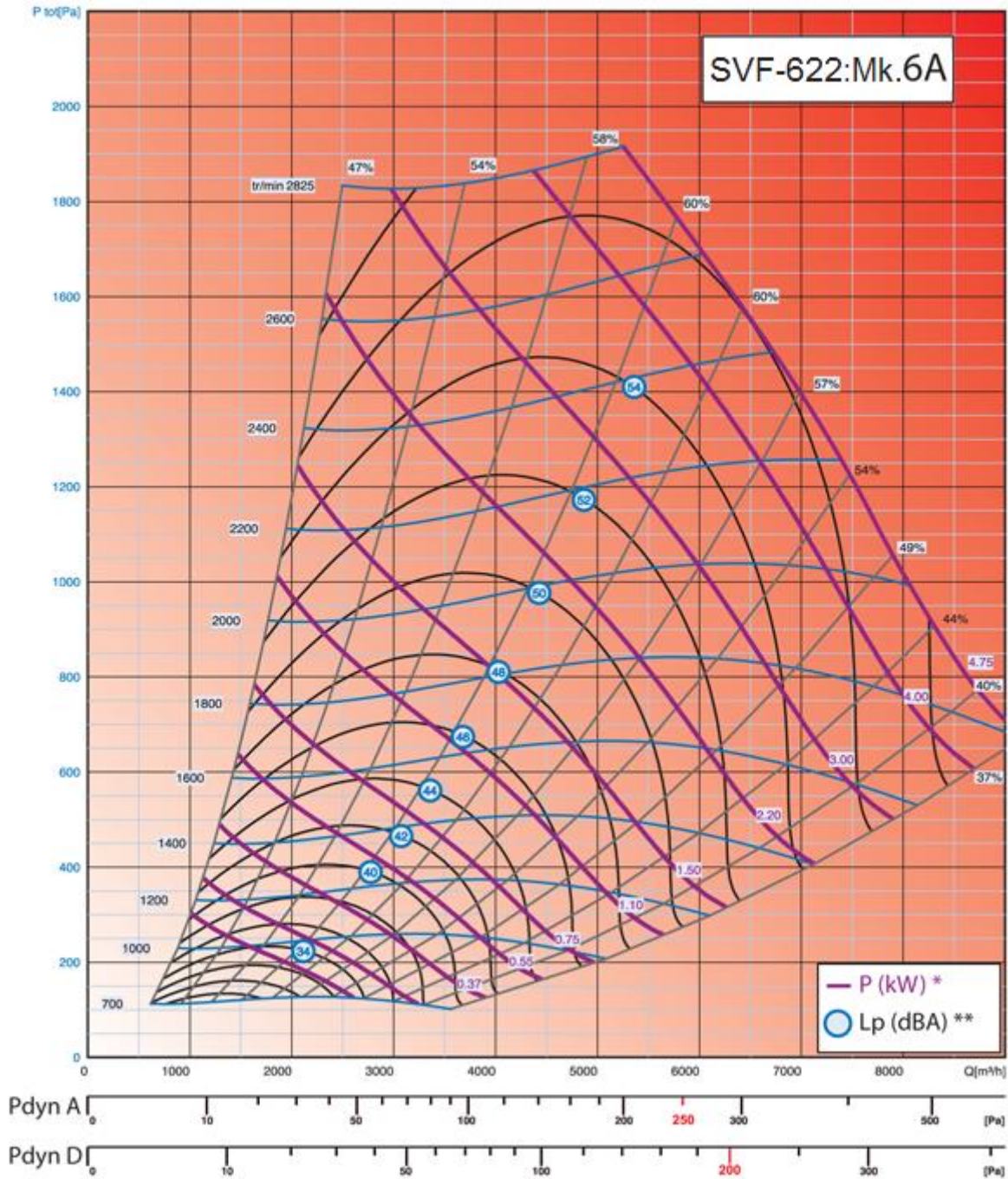

# INSULATED CASING CLASS SMOKE VENTING FAN

Rev.01  
27-05-2015

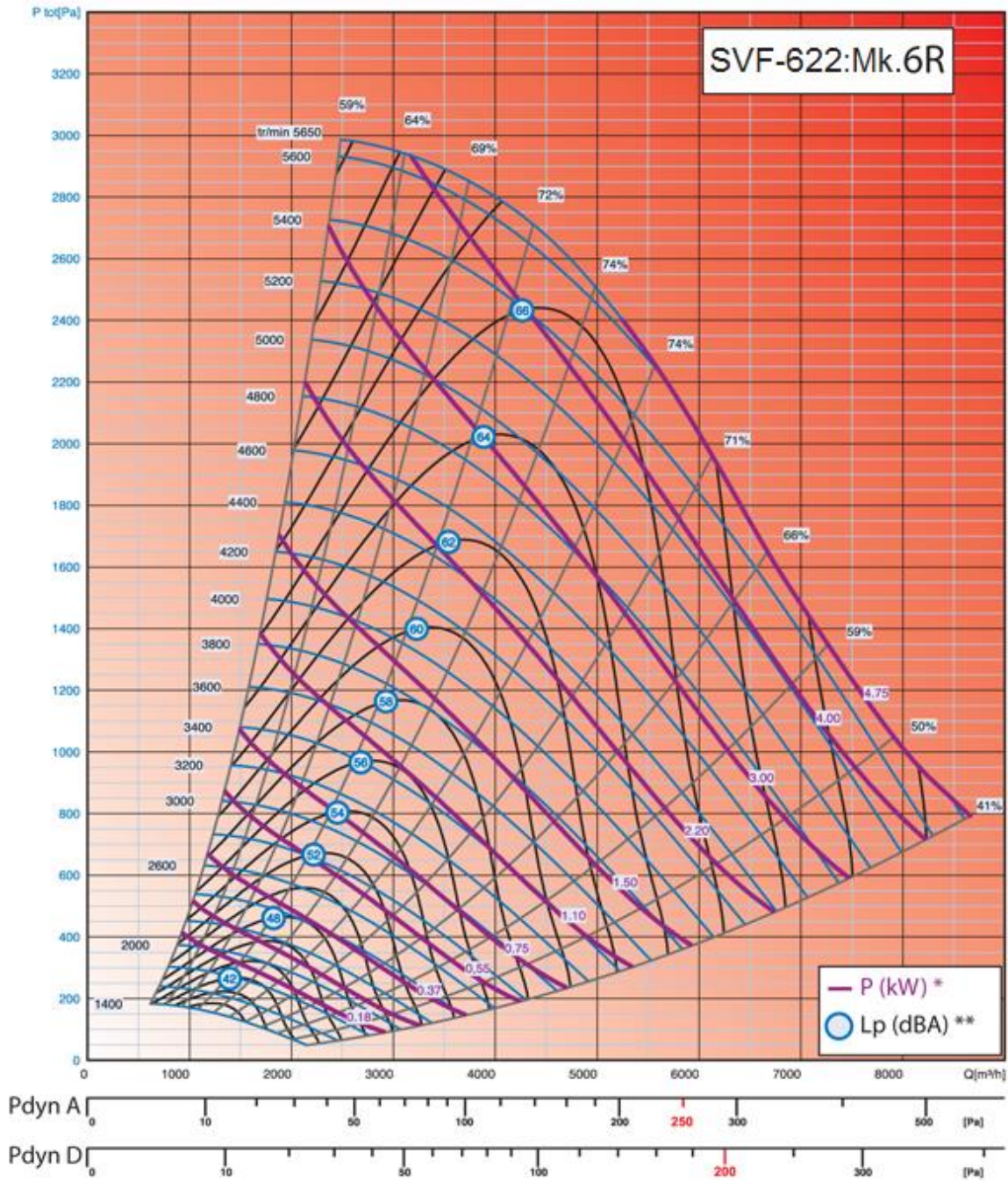

# INSULATED CASING CLASS SMOKE VENTING FAN

Rev.01  
27-05-2015

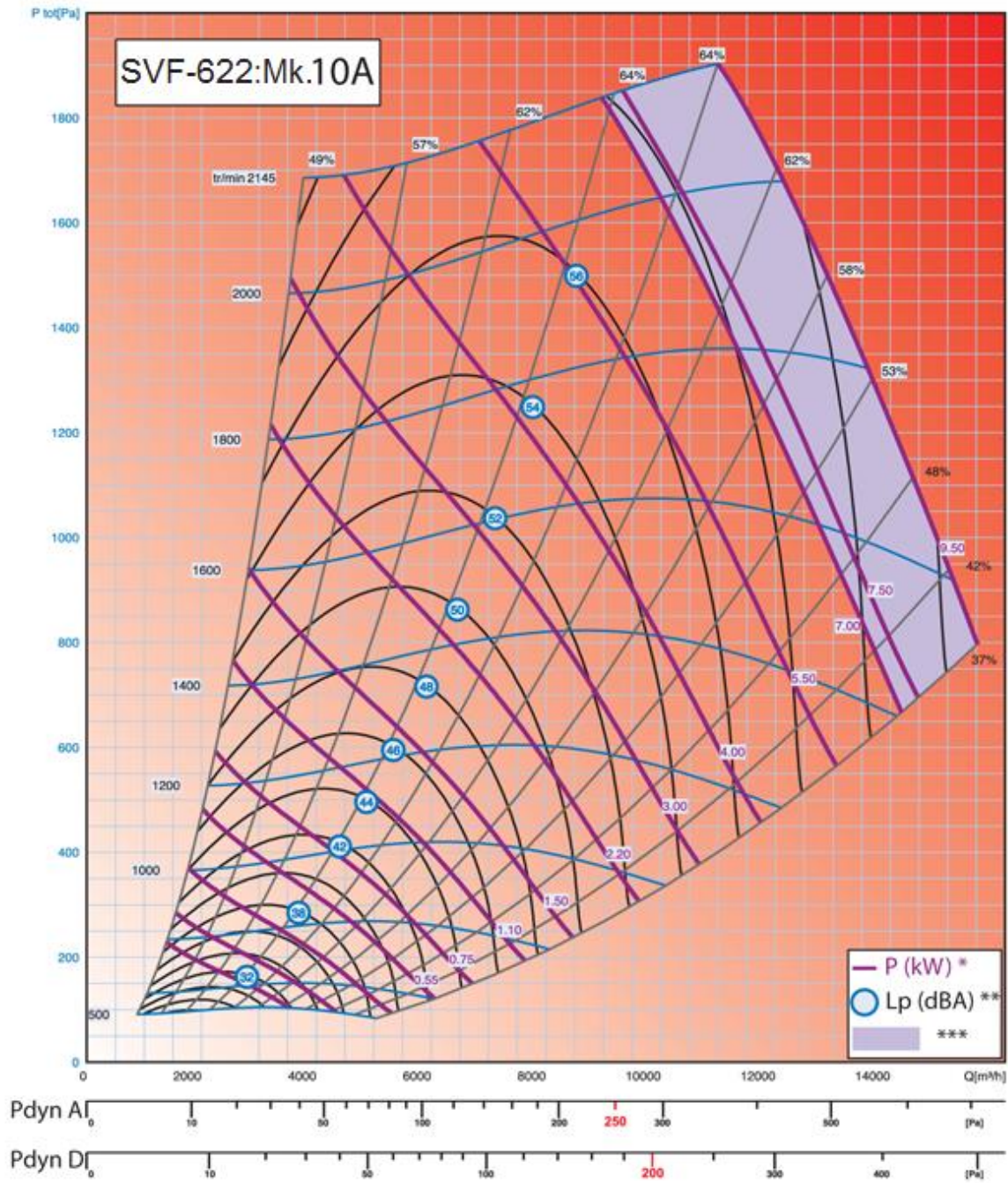



# INSULATED CASING CLASS SMOKE VENTING FAN

Rev.01  
27-05-2015

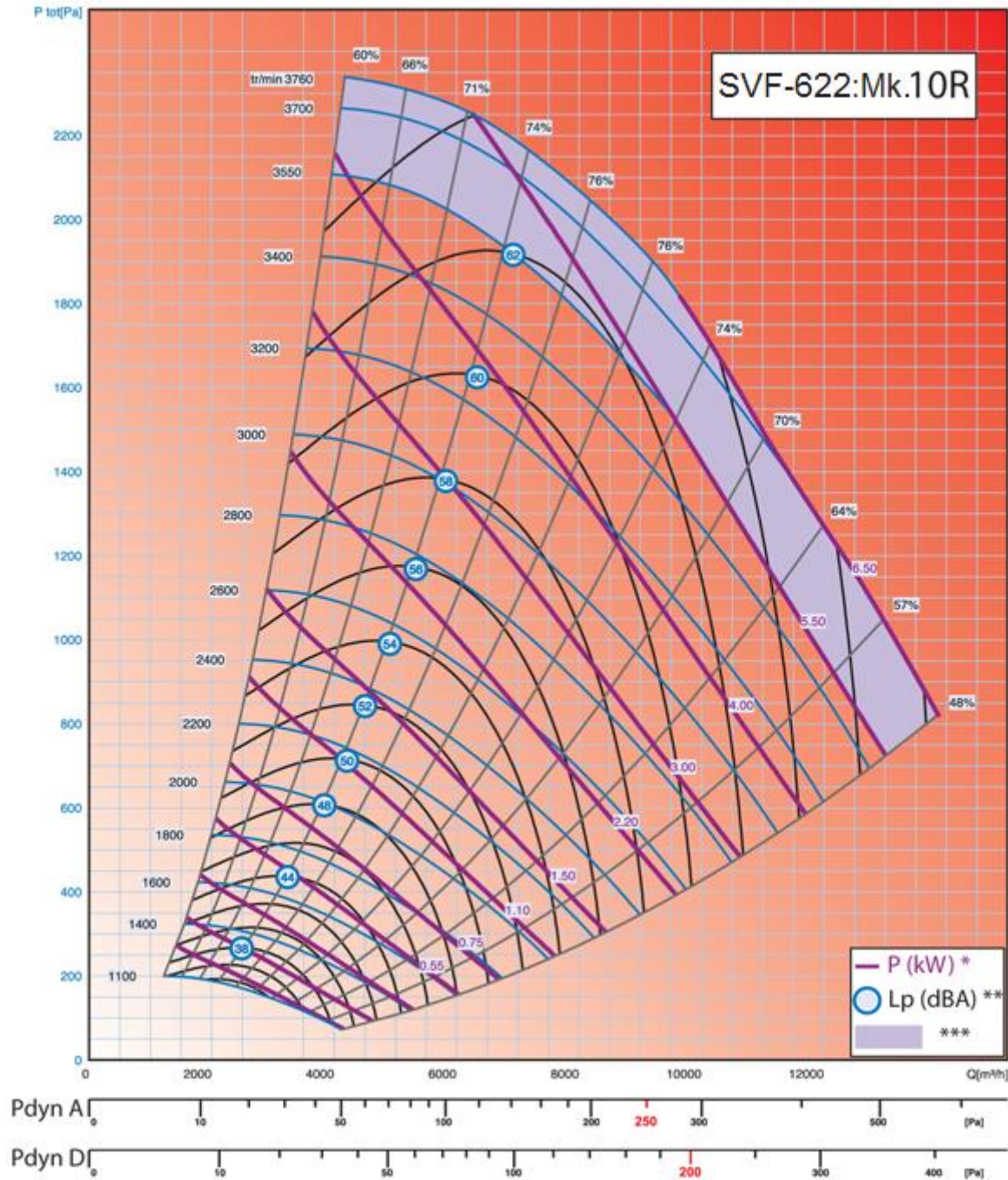

# INSULATED CASING CLASS SMOKE VENTING FAN

Rev.01  
27-05-2015

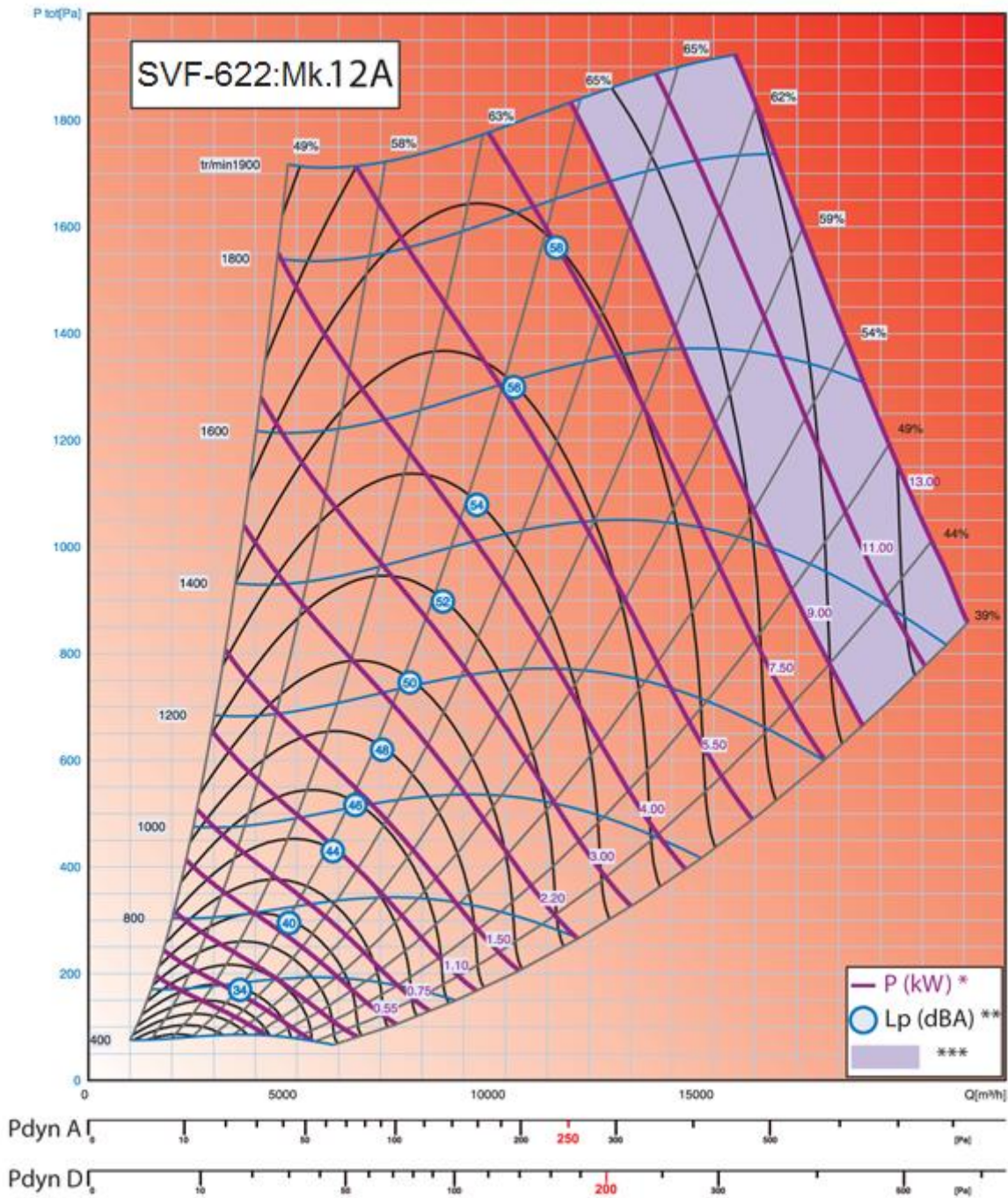

# INSULATED CASING CLASS SMOKE VENTING FAN

Rev.01  
27-05-2015

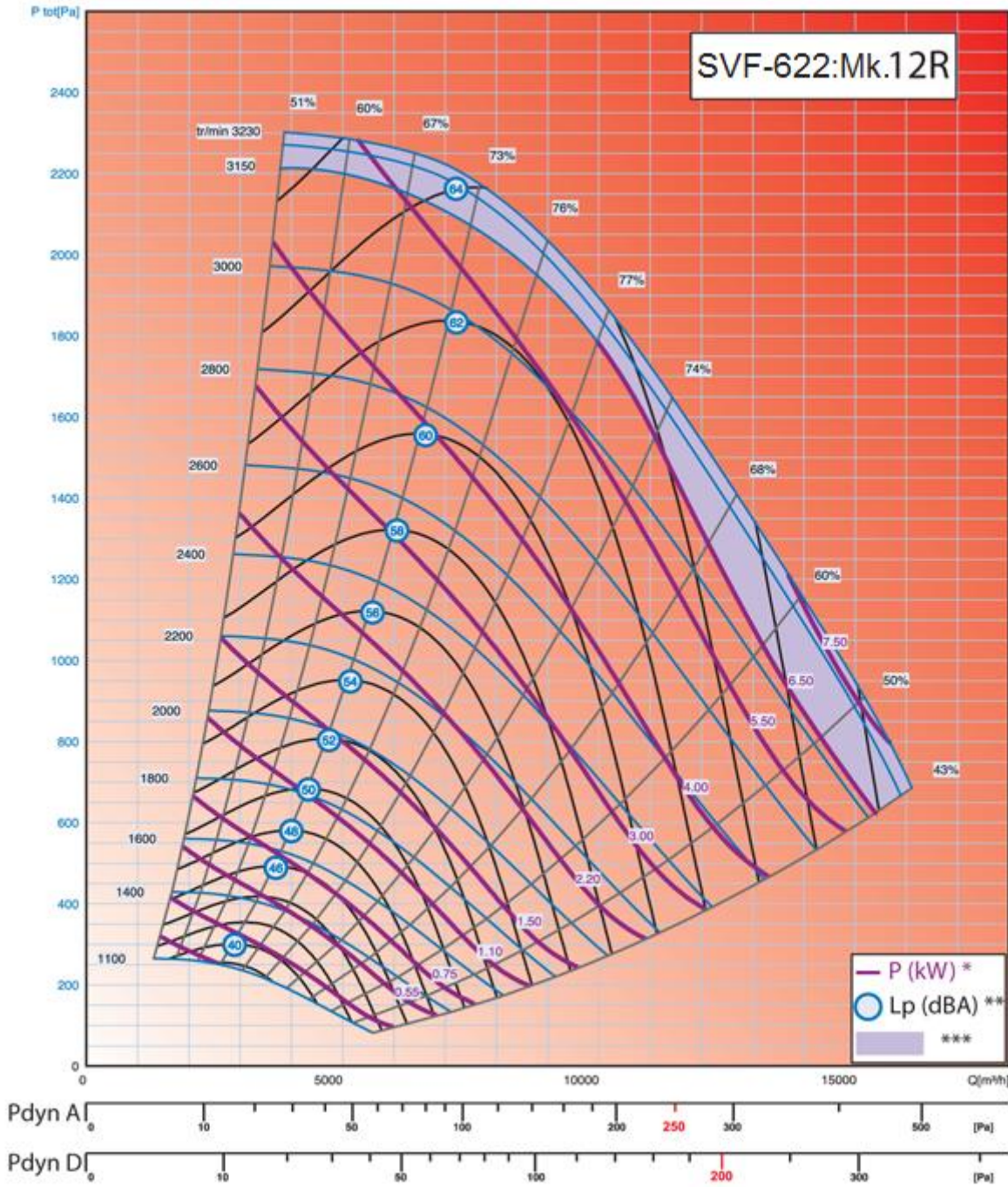

# INSULATED CASING CLASS SMOKE VENTING FAN

Rev.01  
27-05-2015

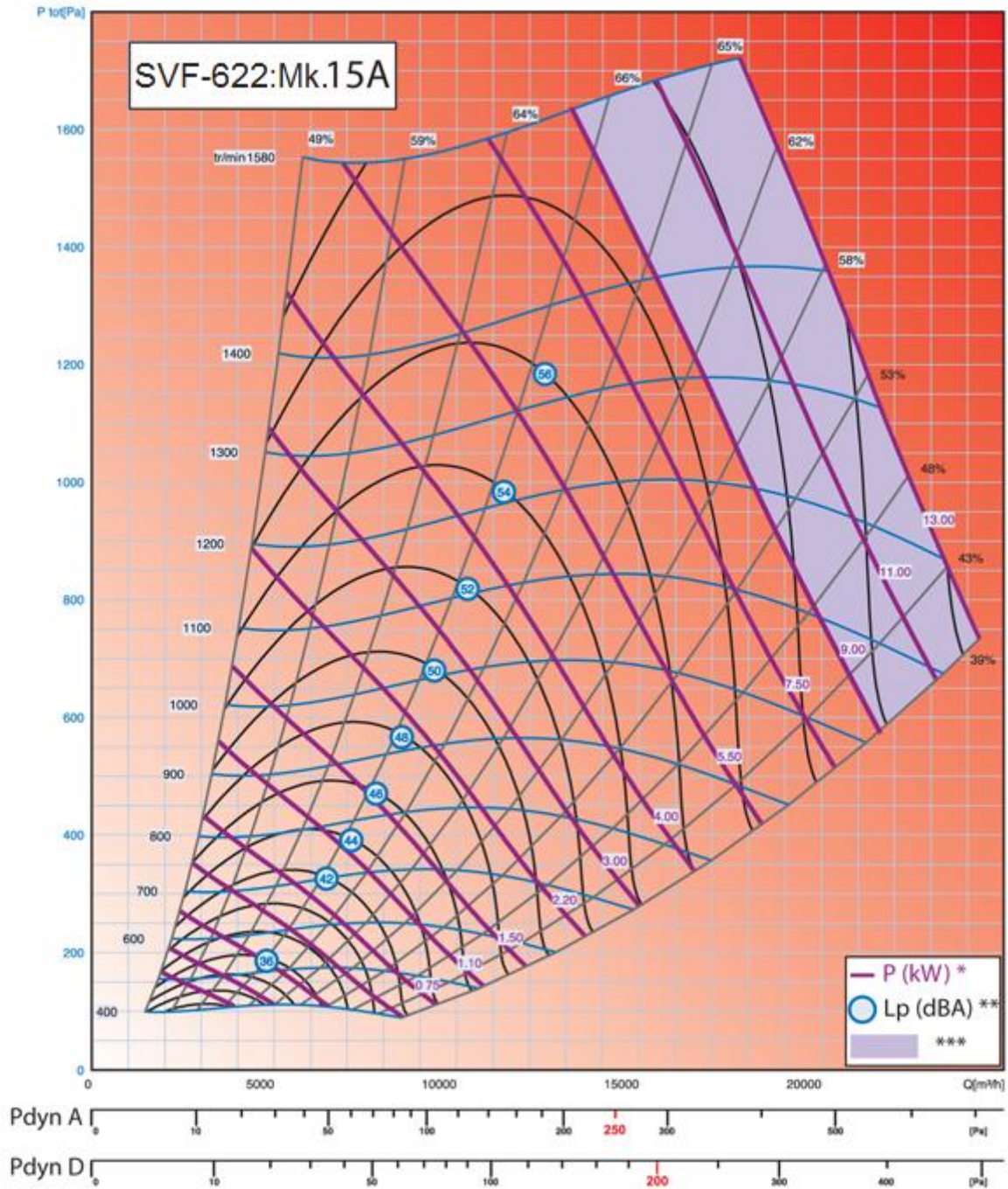

# INSULATED CASING CLASS SMOKE VENTING FAN

Rev.01  
27-05-2015

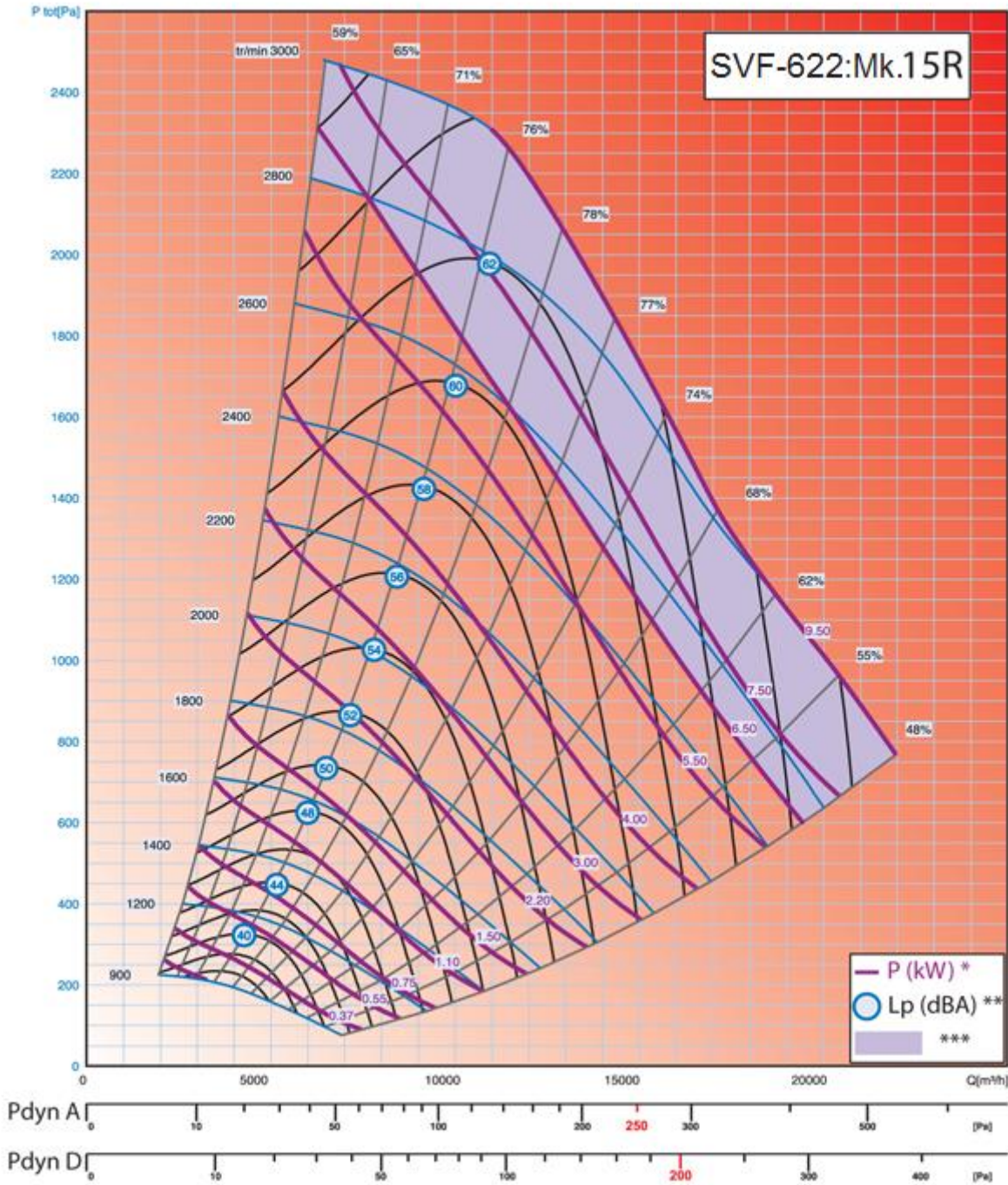

# INSULATED CASING CLASS SMOKE VENTING FAN

Rev.01  
27-05-2015

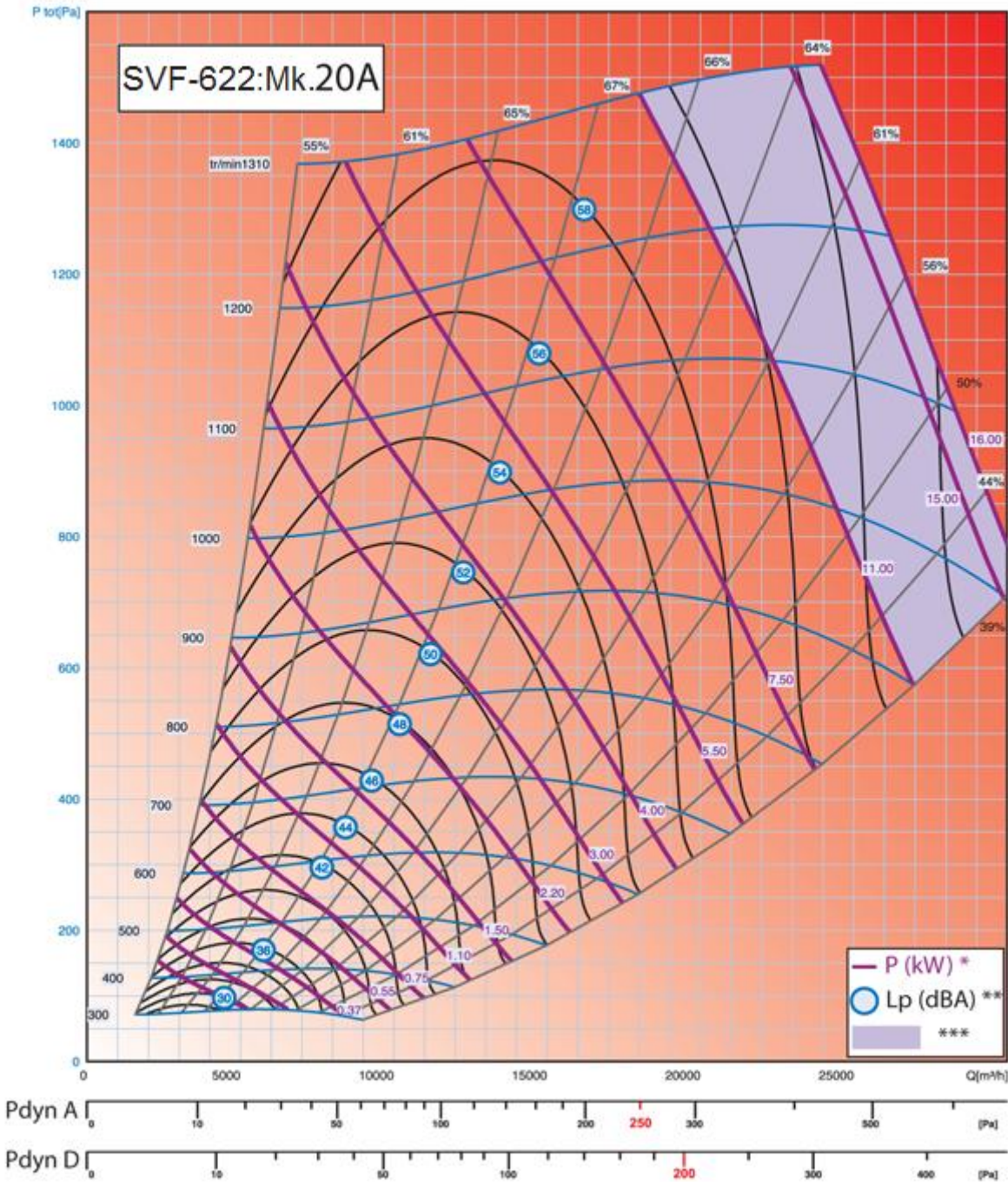

# INSULATED CASING CLASS SMOKE VENTING FAN

Rev.01  
27-05-2015

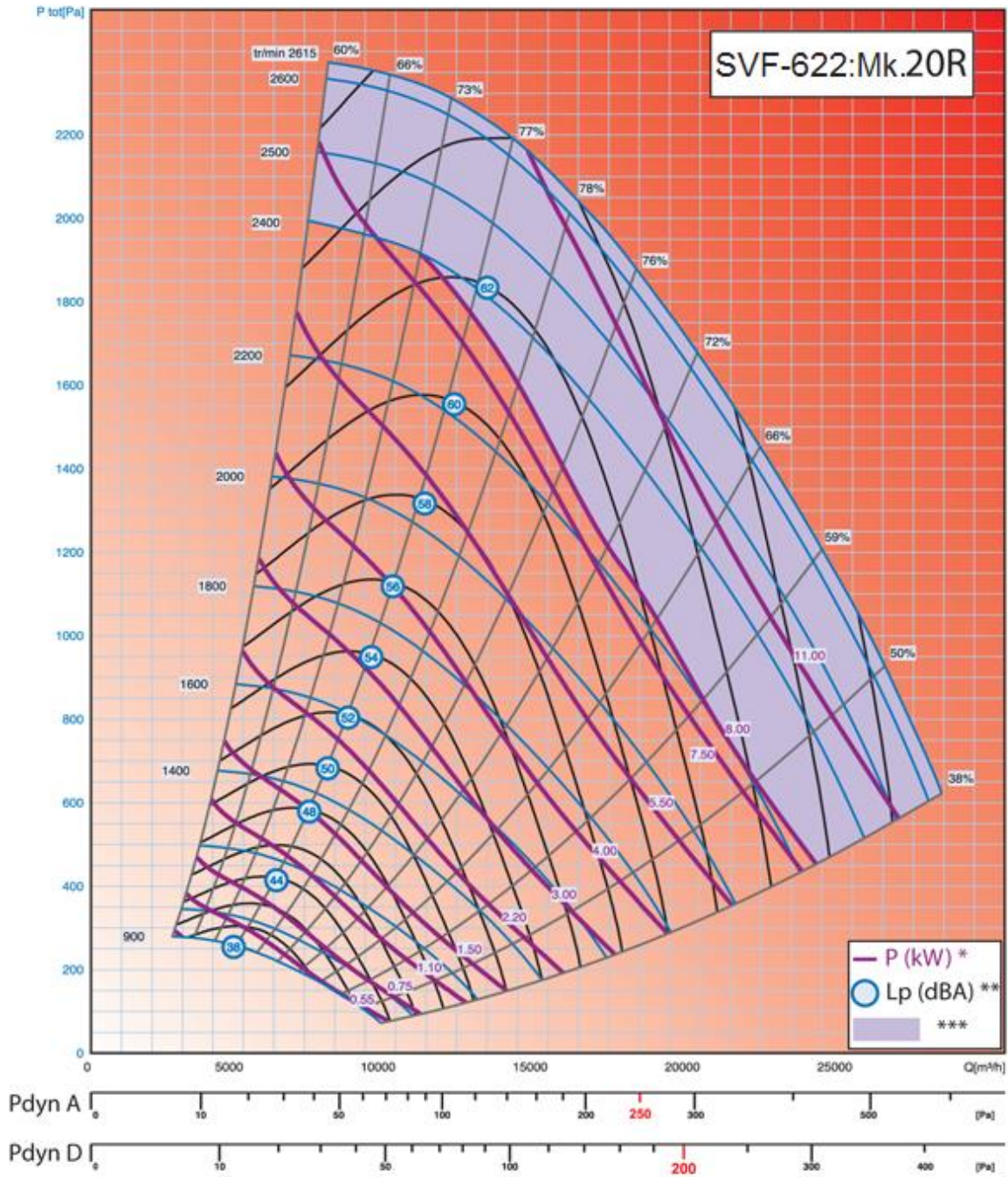

# INSULATED CASING CLASS SMOKE VENTING FAN

Rev.01  
27-05-2015

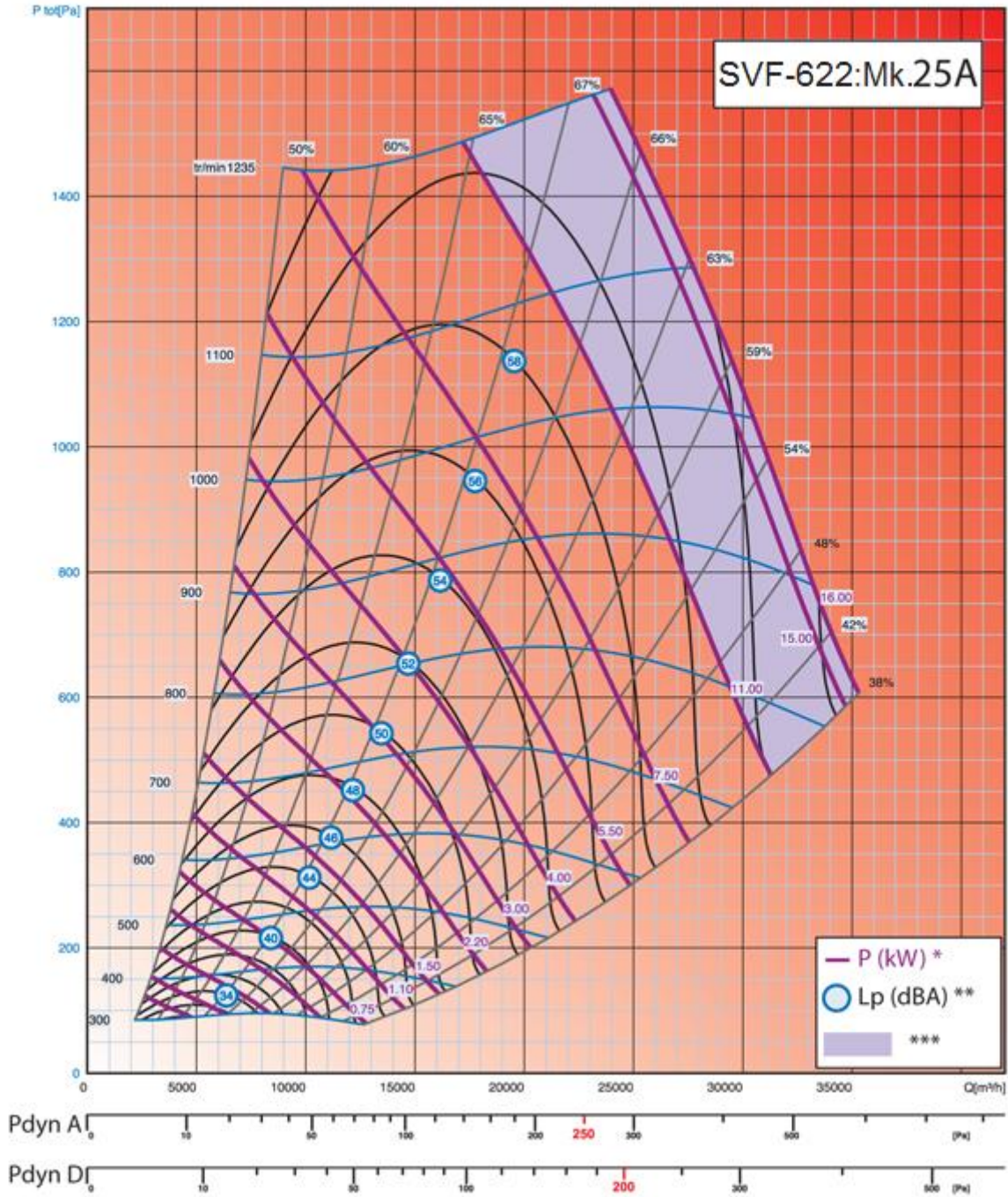



# INSULATED CASING CLASS SMOKE VENTING FAN

Rev.01  
27-05-2015

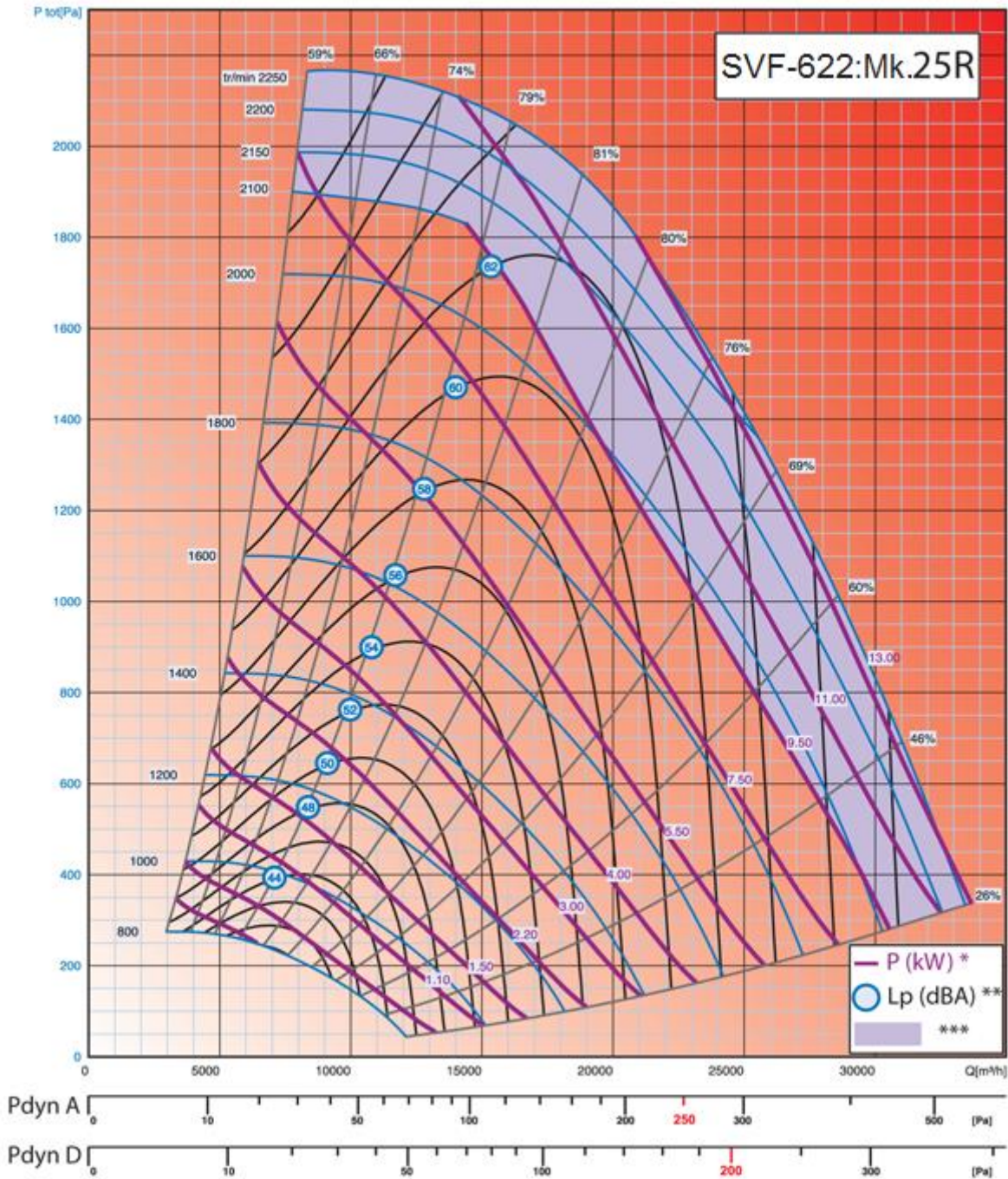

# INSULATED CASING CLASS SMOKE VENTING FAN

Rev.01  
27-05-2015

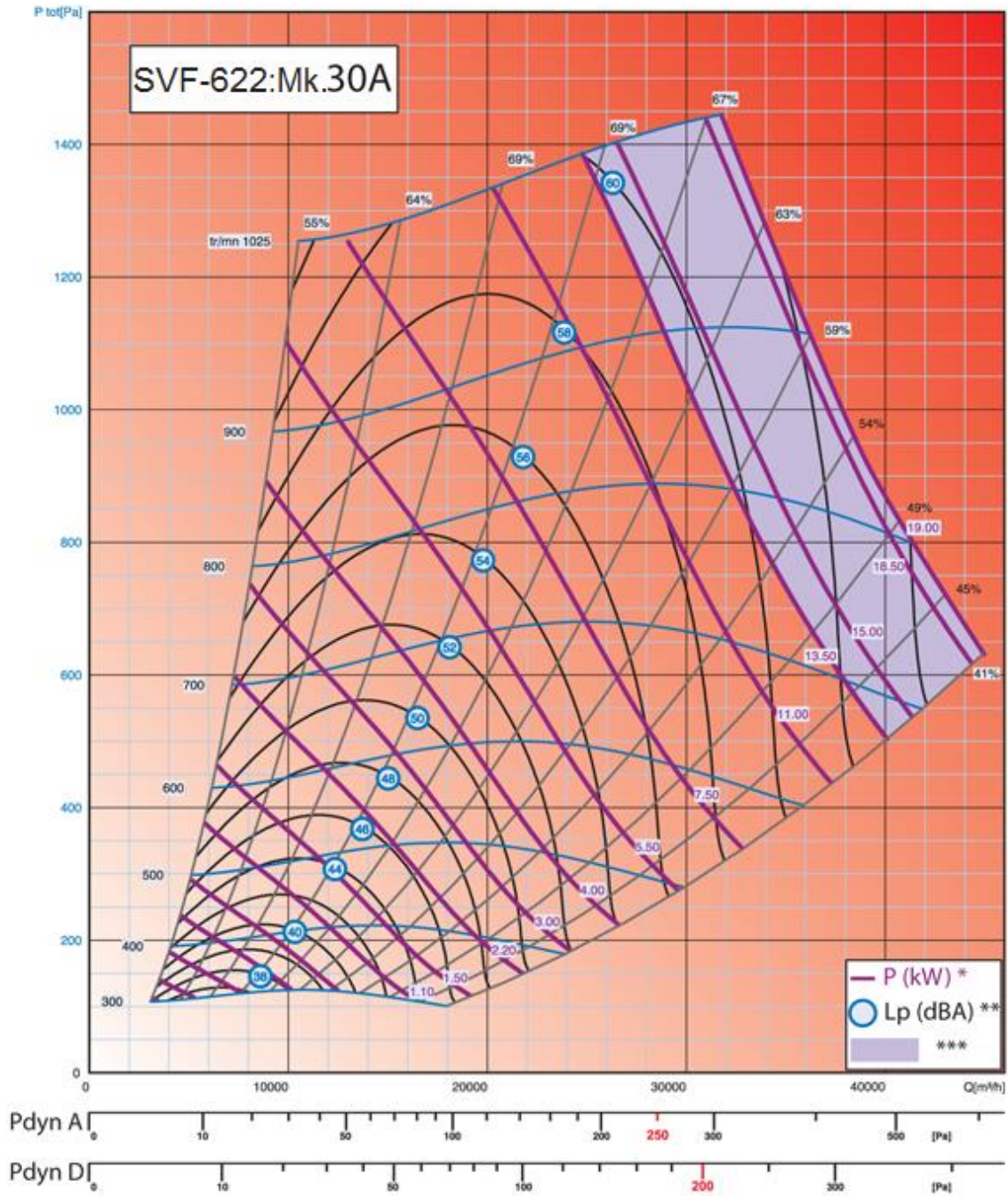

# INSULATED CASING CLASS SMOKE VENTING FAN

Rev.01  
27-05-2015

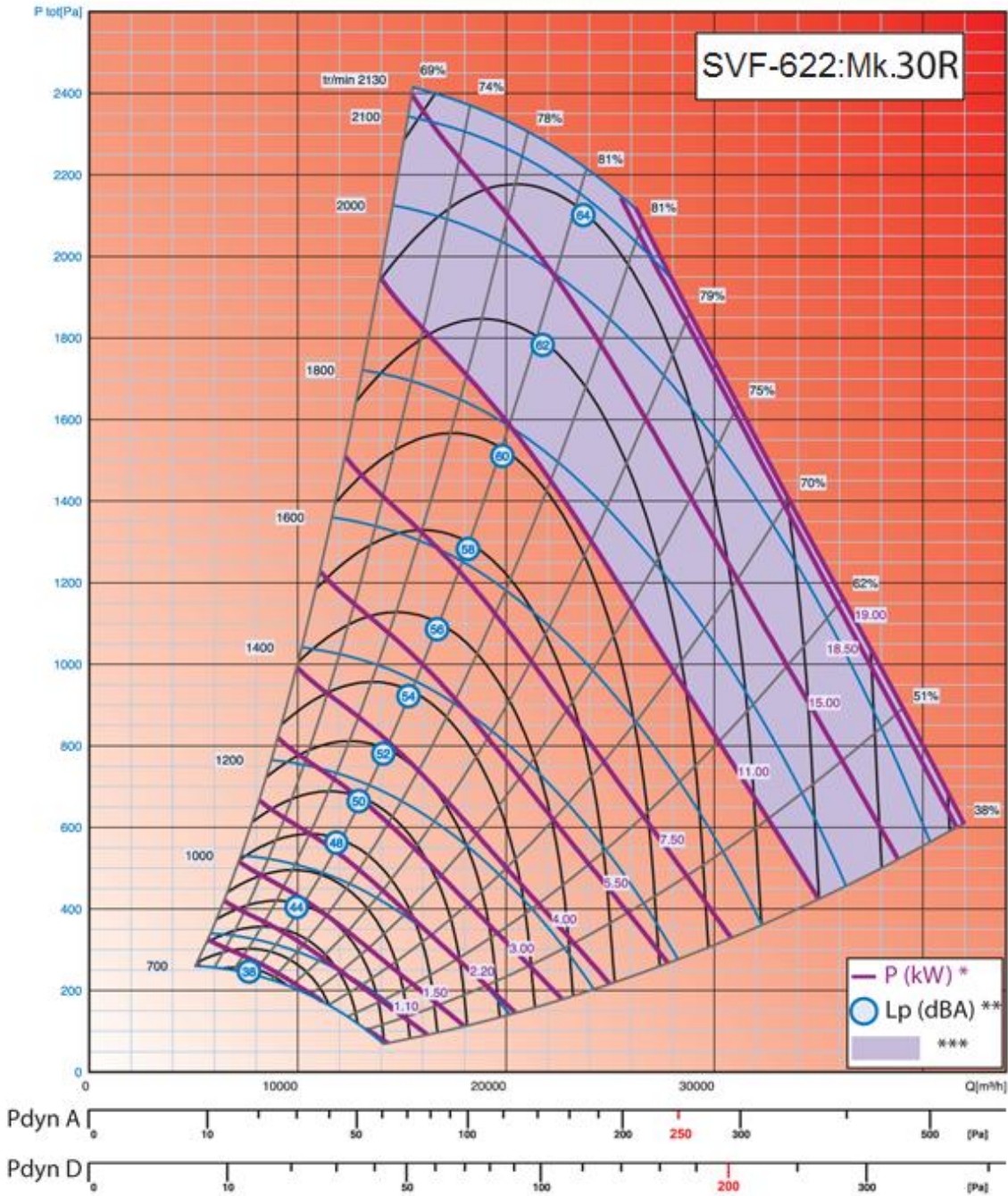

# INSULATED CASING CLASS SMOKE VENTING FAN

Rev.01  
27-05-2015

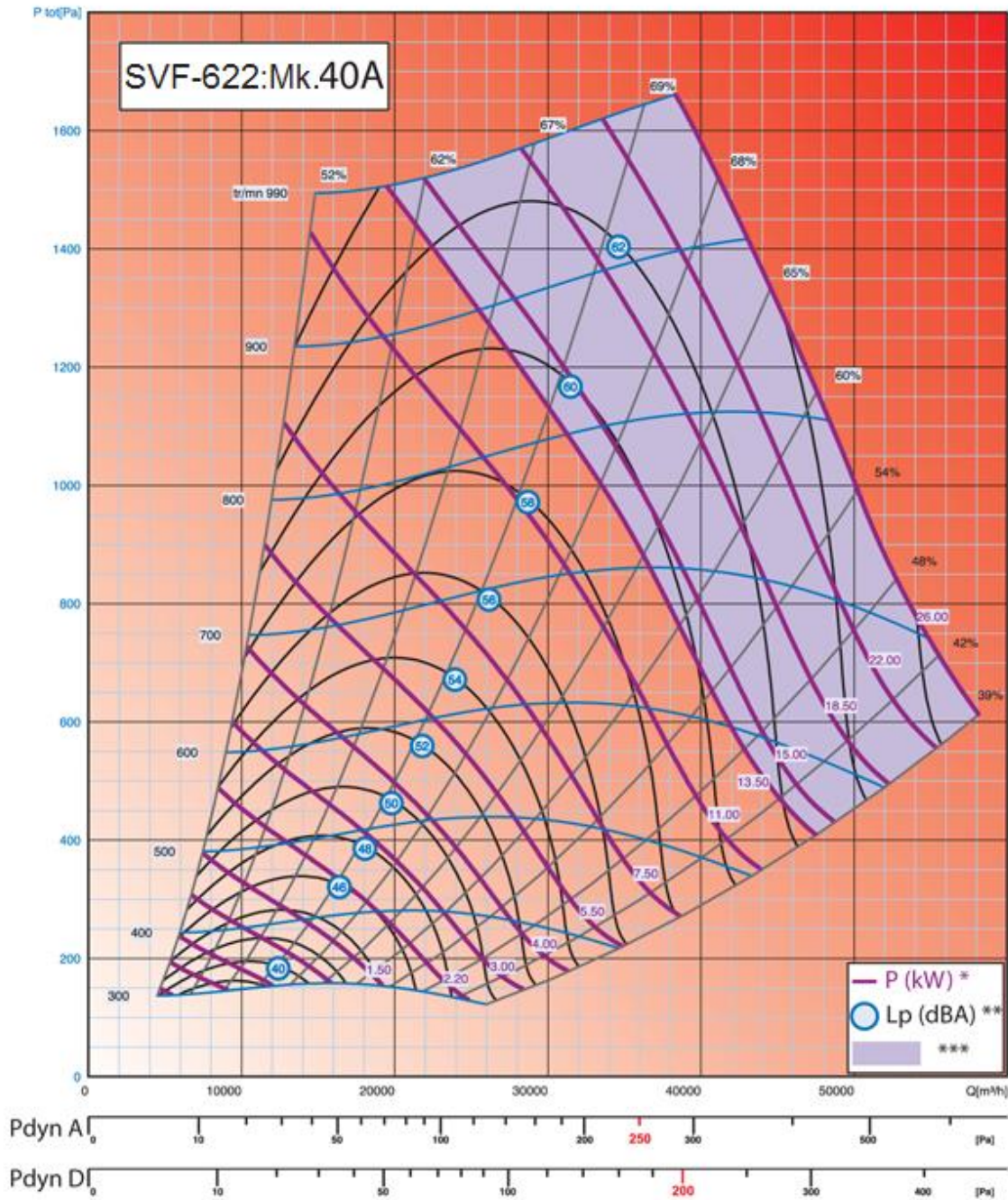

# INSULATED CASING CLASS SMOKE VENTING FAN

Rev.01  
27-05-2015

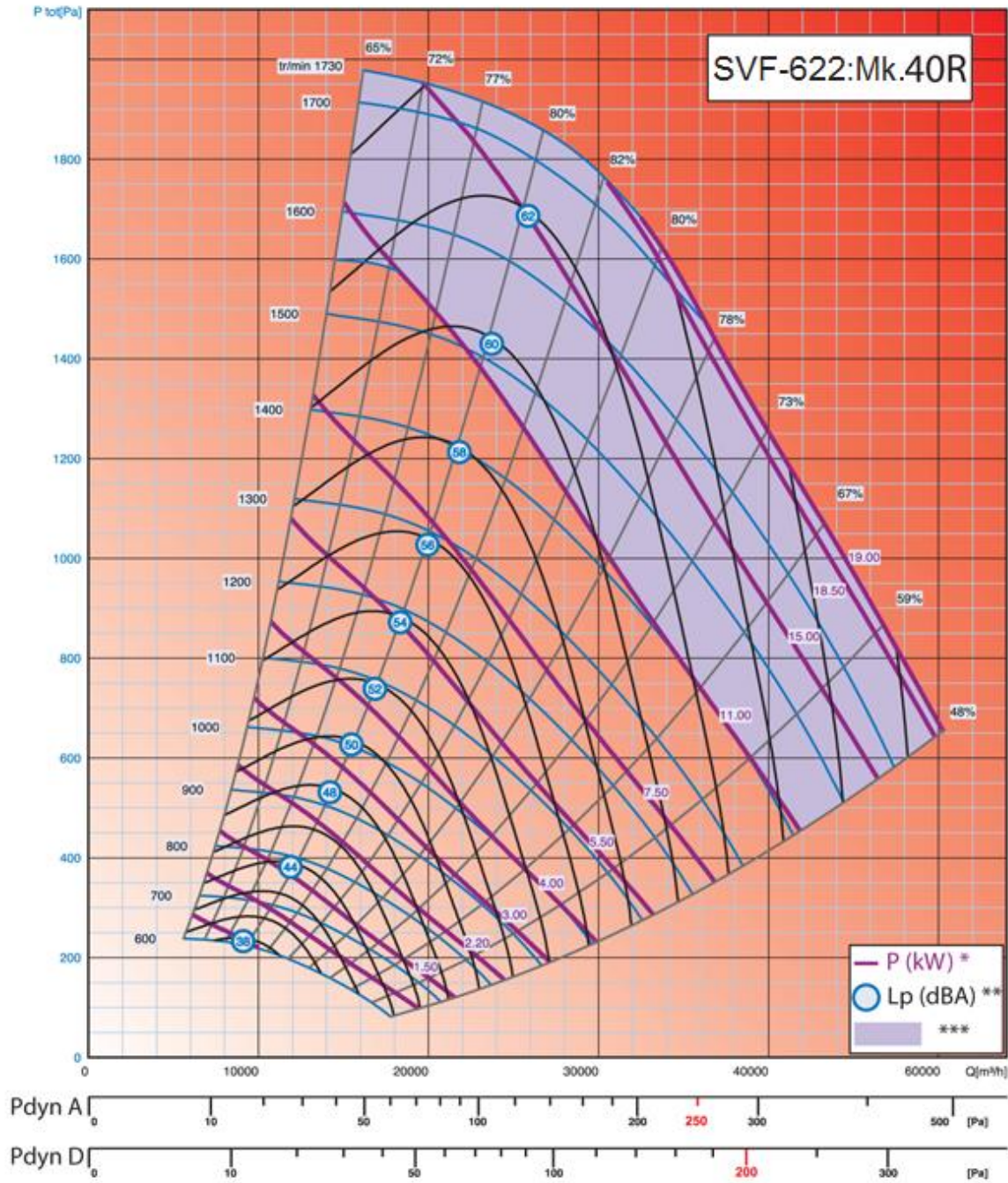

# INSULATED CASING CLASS SMOKE VENTING FAN

Rev.01  
27-05-2015

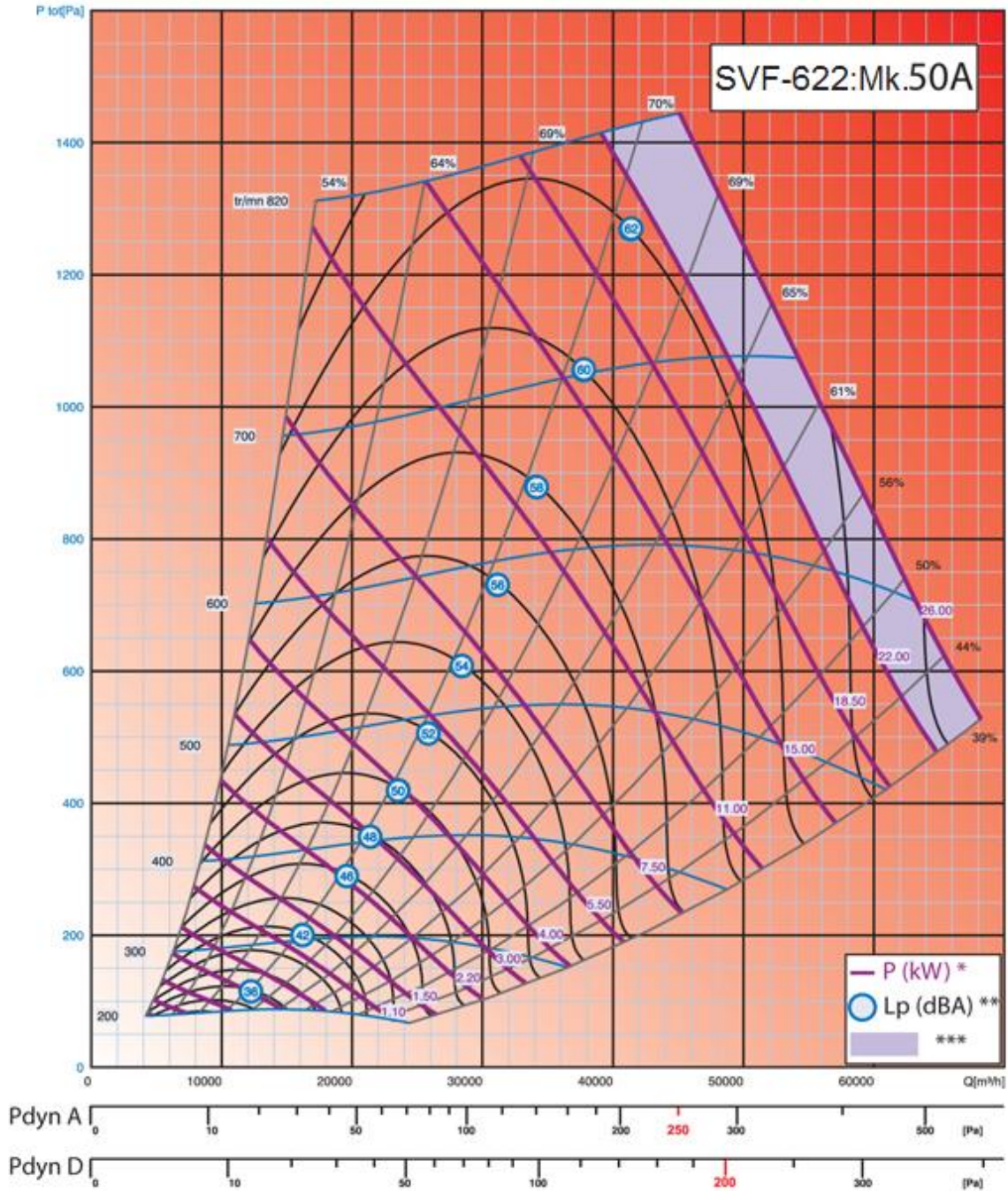

# INSULATED CASING CLASS SMOKE VENTING FAN

Rev.01  
27-05-2015

