

Movement by Perfection

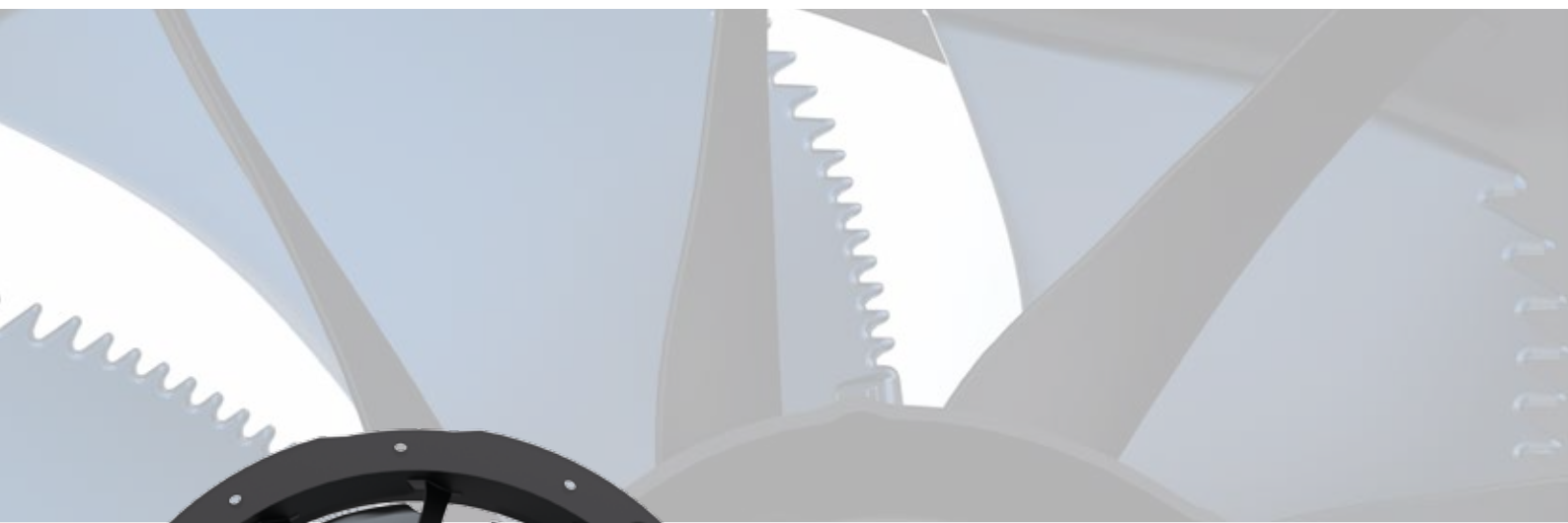

The Royal League in ventilation, control and drive technology



ZAplus

Flexible, economical and eco-friendly

ZAplus – the modern air feed method



Bionic FE2owlet blade
+ multifunctional fan housing
+ reliable ECblue or AC drive
= your advantage in terms of efficiency for every application

The ZAplus housing allows an optimal air feed, which was developed using CFD (the most up-to-date flow simulations). The housing was produced by means of high performance composite injection moulding. The production process ensures the exact reproducibility of all shapes. On the suction side, the air feed is decisive for optimal fan operation. The well-known FE2owlet blade design and ZAplus nozzle interact in perfect harmony.

On the pressure side, the volume flow rate of an axial fan generally contains a high rotating flow proportion, which is disadvantageous for efficient and low-noise operation. ZAplus possesses guide vanes and a short diffusor to counteract this flow behaviour resulting in a consistently noticeable improvement in performance data and acoustics.

Advantage in terms of performance

- More air power
- Reduction in operating costs
- Short payback period
- Reduced and redirected sound emission
- Meets the highest demands with regard to UV stability and durability
- Extension possible thanks to extensive accessories (diffusor, heating tape, control engineering and much more)

Advantage in terms of environmental protection

- No transport packaging
- 100% speed controllable
- ErP2020 compliant, also with regard to AC technology
- Acoustic upward directivity
- Simple retrofitting of existing systems (RETRO-FIT)

Advantage in terms of assembly/processing

- Wider application area
- Optimal handling
- No sharp edges
- Lighter than conventional units
- Highest level of stability, since nozzle and mounting are produced from one piece
- Protected cable guide
- Optimum corrosion protection
- Installable in 4 versions, depending on whether it is a pressure or suction application: On-top, semi-flattop, flattop or with Q-plate
- Double-sided flange
- As standard for both airflow directions





Unique advantages – convincing performance

ZAplus will increase the performance of your devices.

In addition to the initial equipment, ZAplus can be easily retrofitted. Fan systems with ZAplus offer, depending on requirements:

- More air handling capacity with the same area
- The same air handling capacity with significantly reduced power consumption and noise generation

Fan acoustics are improved, with an additional upward directivity reducing the horizontal acoustic pressure. Fan systems with ZAplus are available with conventional AC motors and highly efficient ECblue motors. For both variants ZIEHL-ABEGG offers solutions for all areas of application.

Existing end devices can be kept in use thanks to a simple fan replacement. Also in light of global warming, existing systems can be upgraded with ZAplus systems in order to meet new requirements. An appropriate flange on the light ZAplus housing makes the conversion fast and uncomplicated.

ErP guideline
The ErP guideline valid in Europe is to be complied with beyond the year 2020, also with regard to AC technology!

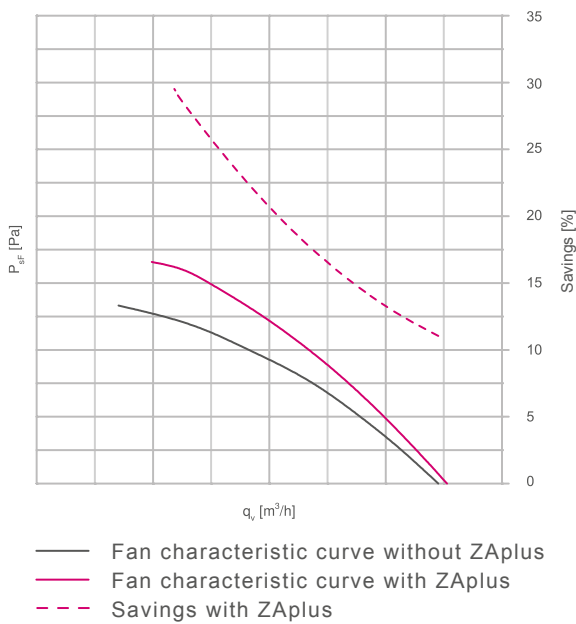

Advantage in terms of performance

- More air power
- Reduction in operating costs
- Short payback period
- Horizontal acoustic pressure significantly reduced
- Meets the highest demands with regard to UV stability and durability
- Extension possible thanks to extensive accessories (diffuser, heating tape, control engineering and much more)



All-purpose – efficiently designed

ZAplus is the right choice for RETRO-FIT projects.

Energy-related improvements have become a global trend. Also on account of more stringent environmental guidelines, existing systems are being increasingly converted to enable further potential years of operation. ZAplus systems are ideally suited for such purposes. Lower weight ensures easy handling during conversion. Efficiency levels of fans achieve the desired result.

3, 2, 1, ... it's all done!

- Remove old fans and cut out hole circle.
- If the complete housing wall is removed, ZAplus can be delivered including square wall ring plate.
- Bolt the ZAplus system to the housing in just a few steps.
- Pull the connecting lead through the cable duct and wire it on the motor.
- Assemble protective grille if required. Done.

ZAplus offers a flange on both sides, and can thus be used for both airflow directions as standard. In many cases, one fan in stock can be used for numerous devices saving time and money. Fans with ZAplus can continue to be assembled in four variants: On-top, semi-flattop, flattop, Q-plate, thus providing devices with every design option possible.

Advantage in terms of assembly/processing

- Wider application area
- Optimal handling
- No sharp edges
- Lighter than conventional units
- Highest level of stability, since nozzle and mounting are produced from one piece
- Protected cable guide
- Optimum corrosion protection
- Installable in 4 versions, depending on whether it is a pressure or suction application: On-top, semi-flattop, flattop or with Q-plate
- Double-sided flange
- As standard for both airflow directions

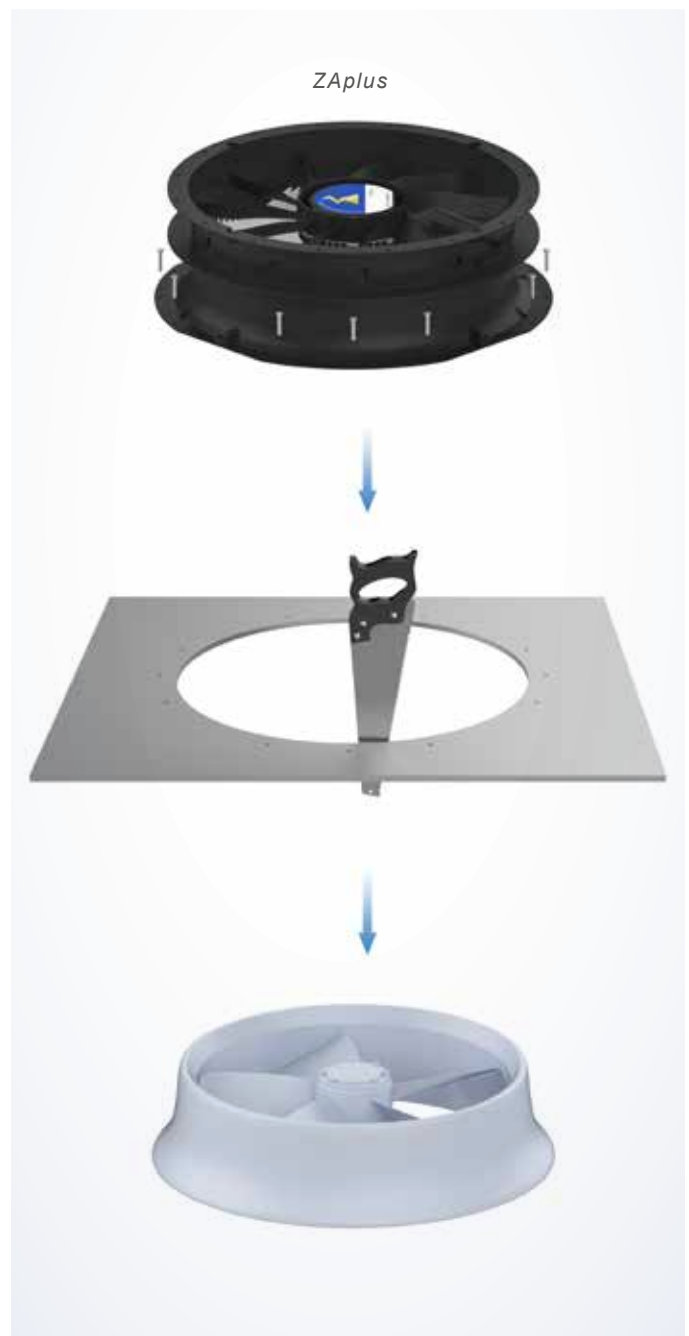

ZAplus – pays off

Low consumption + long service life = long-term savings!

Savings

Operating costs make up over 90% of the total product life costs of a system. Thanks to the high efficiency levels of fans, system operating costs are significantly reduced.

Durability

Every product development undergoes an extensive approval process at ZIEHL-ABEGG, which includes the following processes:



Example calculation:

Device	Condenser
Pressure loss	110 Pa
Volume flow rate	25,000 m ³ /h

Standard fan frame size	800 mm, EC technology
Speed	1,101 rpm
Power consumption	2,536 W
Acoustic power	85.7 dB

ZAplus fan frame size	800 mm, EC technology
Speed	1,033 rpm
Power consumption	2,032 W
Acoustic power	83.8 dB

**A saving of 504 watts
at 0.20 EUR/kWh
at 6,000 operating hours/year
= 604.80 EUR/year/fan**

Development phase

- Strength calculation
- FEM analysis and Moldflow simulation
- Tests under laboratory conditions
- Resistance to cold according to DIN EN 60068-2-1 at -40°C
- Heat resistance according to DIN EN 60068-2-2 up to +80°C
- Temperature change according to DIN EN 60068-2-14 from -40°C to +65°C
- Shock load according to DIN EN 60068-2-27
- Vibration load according to ISO 14694

Post-development

- Endurance tests in free field conditions (outdoor installation) for at least 2 years
- Accelerated life tests in normal conditions
- Accelerated life tests in extreme conditions
Cold test bench – Switzerland, Schilthorn at an altitude of 2,970 m
Heat test bench – Turkey, Istanbul at an altitude of 40 m



Eco-friendly and sustainable

Protects the environment over the entire life cycle.

The high system efficiency levels of ZPlus systems ensure low energy requirements, thus protecting the environment - on a daily basis. Legal requirements concerning environmental protection and stipulated minimum efficiency levels are easily met with ZPlus systems. In this way, systems can be globally equipped to be future-proof.

ZPlus protects the environment also in terms of transport, storage and assembly. Its lighter weight compared to conventional fans facilitates storage and transport.

Transport takes place without repackaging. This has a twofold positive effect: due to a reduction in cardboard boxes and faster handling during delivery and assembly.

Fans with ZPlus are virtually 100% recyclable. The housing and most of the fan can be completely recycled.



Eco-friendly and safe dispatch, without cardboard boxes

Ventilation systems by perfection

A wide variety of application areas, successfully tested ZPlus systems can be used in a wide variety of ventilation system applications. Since the market launch, application areas where they have proved successful include the following:

1 Agriculture

- Stall ventilation
- Stall air circulation
- Air purifier
- Greenhouses
- Drying technology
- Storage

2 Transformers

- Radiator cooling
- Oil coolers

3 4 Refrigeration and air-conditioning systems

- Condensers/chillers
- Evaporators/blast freezers
- Fan heaters
- Ventilation systems
- Wall fans
- Tubular fans
- Heat pumps

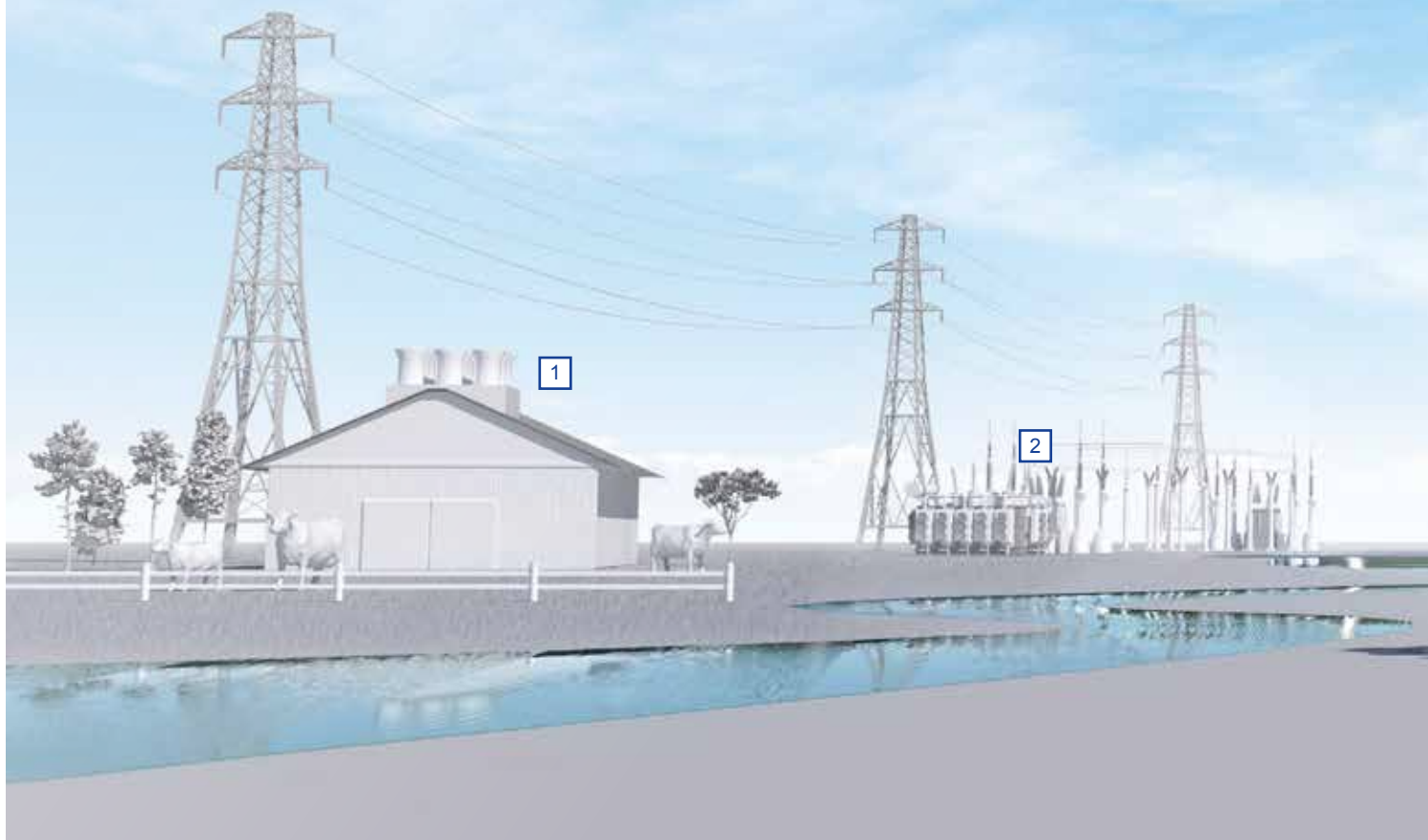



Accessories for ZAPLUS – We don't believe in impossible

Special applications require special equipment. Fan systems with **ZAPLUS** can be expanded with special accessories for special purposes. Simple to assemble and in the accustomed high ZIEHL-ABEGG quality.



Diffusor ZAPLUS+

Even more volume flow rate in the lower pressure range

- Easy assembly at the place of operation
- Low transport costs
- Sheet metal, coated, black
- Retrofittable, screwed to ZAPLUS
- Increased air handling capacity
- Acoustic upward directivity
- UV-resistant

- Fan characteristic curve without ZAPLUS
- Fan characteristic curve with ZAPLUS
- Fan characteristic curve with ZAPLUS+
- - - Savings with ZAPLUS
- - - Savings with ZAPLUS+

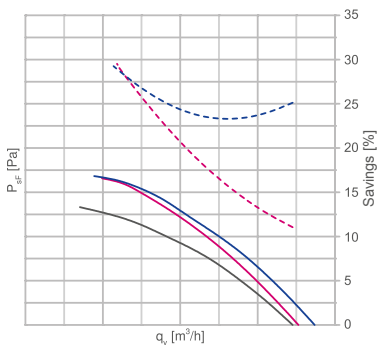

Square wall ring plate

1:1 exchange of existing Q-plates

- Compatible solution for standard wall ring plates
- High-performance composite material, black
- UV-resistant
- Corrosion-resistant

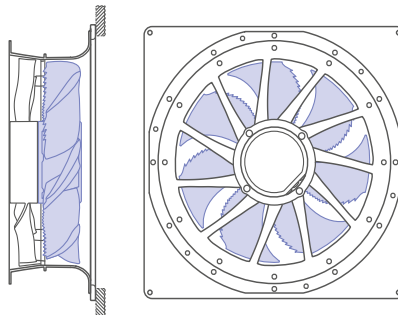

Heating tape

Prevents head gap icing-up

- UL certified
- Optionally with insulating shell
- Easy to retrofit
- Protection class IP54
- UV-resistant

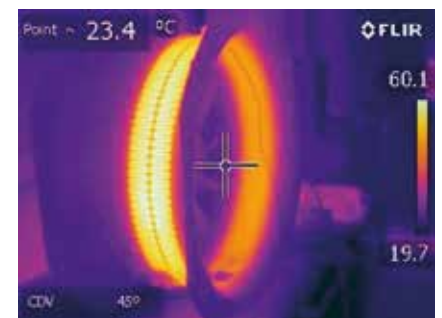

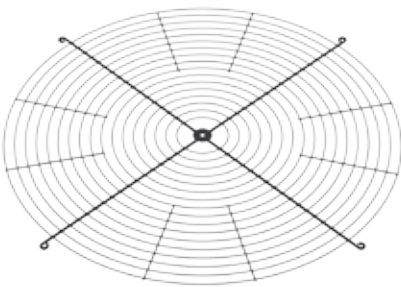

Finger protection

Safety according to the standards

- High corrosion protection thanks to powder-coated steel or stainless steel
- Optionally for suction or pressure side
- Compliant with DIN EN ISO 13857:2008

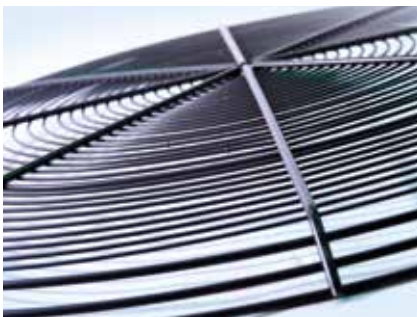

Completed terminal box

For special installation situations

- Aluminium or plastic
- Protection class IP65
- Coating on request



Cable/plug

Plug & Blow

- Fast start-up
- Individual cable lengths
- Protected cable guide (not shown in the picture)



The Royal League



© ZIEHL-ABEGG SE - EN - MA - 10/2016 - 2.000 - Klunker & Ewald - Subject to technical modifications.
This brochure contains information for your guidance. No guarantee is provided with regard to the accuracy of all information and no legal claims may be derived from this. Reproduction of this information, or extracts thereof, is permitted only with written approval.